

OCULUS

PENTACAM®

BASIC CLASSIC HR



 OCULUS®

We focus on progress

 EYE CARE ALLIANCE
1.800.320.2020
www.eyecarealliance.com

Many Patients have Apprehensions before an Examination.

> The eye is an extremely sensitive area

Loss or impairment of sight always produces anxiety.
Both are inconceivable for your patients.

> Your clientele will really appreciate fast, non-contact measurements.

The data gathered and the informative images it produces are the basis for a relationship of trust between patient and physician.

> Win your patients' trust with Oculus Pentacam

The Oculus Pentacam examination method provides you with the best prerequisites for achieving this and retaining your patients over the long term.



Generate the Trust Your Patients Deserve!

Glaucoma screening

My competent eye doctor was the one who found out I have a glaucoma. I am very grateful that he checked my chamber angle and my chamber volume to prevent serious consequences for my eyesight.



Cataract surgery

Before the operation my doctor showed me my cloudy lens by performing a Pentacam examination. I was surprised that I can still see anything at all. My doctor explained the operation to me in clear and easy terms on his PC. That gave me the sense of assurance I needed before the intervention.

Corneal surgery

While planning my cornea transplantation the extremely sharp images produced in the preliminary examination took away my anxiety. I felt like I was in good hands with this physician.



Oculus Pentacam

The Gold Standard in Anterior Se

> Pentacam Basic – the individual model

The Pentacam Basic provides you with an overall view of the anterior segment of the eye in a few seconds.

It generates topographic data on elevation and curvature of the cornea. Automatic measurement activation with quality test assures fast, reproducible and delegable measurements.

The Pentacam Basic can be upgraded to include two software packages and further optional software modules – to suit your specific needs.

> Pentacam Classic – the versatile model

Being equipped with the basic software and two software packages, this gives you a versatile, indispensable device for diagnosis and surgical preparation.

Software packages for refractive and cataract surgery supply you with all the important data needed for preparing refractive pre-examinations, early detection and classification of cataract.

The Pentacam Classic can be expanded to include further optional software modules at any time.

> Pentacam HR – the professional model

The Pentacam HR is our high-resolution professional model. With its optimised optics it offers you absolute image quality.

Pentacam HR Scheimpflug images render impressive representations of IOLs and phakic IOLs.

The contact lens fitting program featuring an integrated and expandable database with over 65,000 lens geometries is included.

An optional feature is the 3D pIOL-simulation software module including aging prediction. This can be used to simulate the position of an iris-fixated phakic IOL now, in 5, 10 and as many as 30 years.

gment Tomography



Pentacam BASIC

The Individual Model

The Pentacam is the gold standard for diagnosis in the anterior eye segment. Even the Pentacam Basic provides you with an overall view of it in a few seconds. It supplies topographic data on elevation and curvature of the cornea. The anterior and posterior surfaces are measured from limbus to limbus. The corneal thickness (pachymetry) is also represented graphically over its entire surface. Thus you do not merely view isolated results (as is the case with ultrasound screening of corneal thickness), but can determine the thinnest point of the cornea and all other irregularities quickly and reliably.

Using the data on the anterior corneal surface, keratoconus detection is performed. Important parameters such as anterior chamber angle, depth and volume are calculated and represented automatically by the software. After manual entry of the tonometrically measured intraocular pressure (IOP), the corrected IOP value is calculated and displayed taking the corneal thickness into account.

In this way the Pentacam supplies the basic parameters necessary for preliminary glaucoma examination. Automatic measurement activation with quality test guarantees quick, reproducible and delegable measurements.

The Pentacam Basic can be upgraded to include two software packages and further optional software modules to suit your specific needs.



Basic Software:

- Qualitative assessment of the cornea
 - Topography and elevation data of the anterior and posterior corneal surface
 - Overall pachymetry, absolute and relative
- Glaucoma screening:
 - Pachymetry-based IOP correction
 - Chamber angle, volume and depth
- Topography based keratoconus detection and classification
- Comparative displays for progression control and follow-up

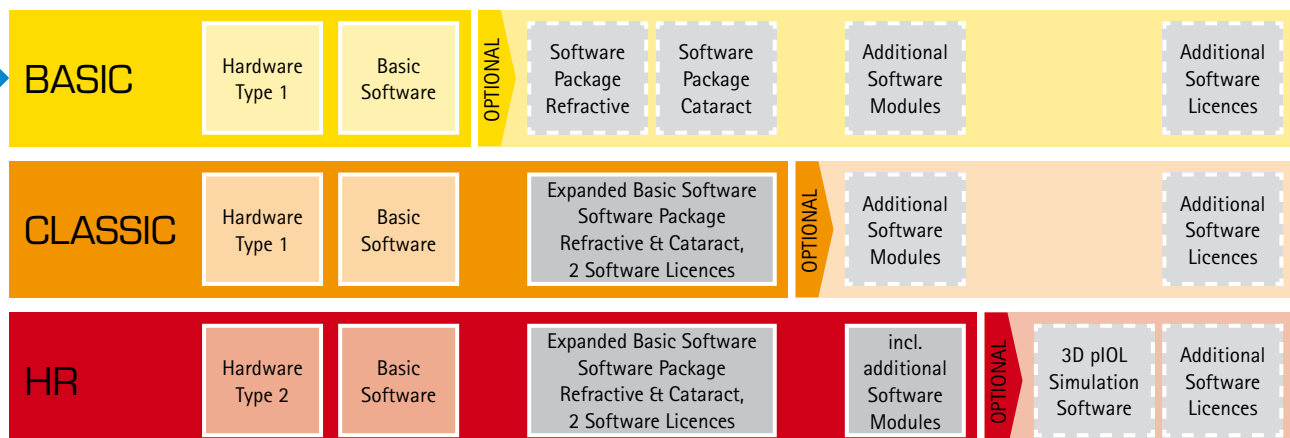

Software Package Refractive:

- ✳ Calculation of corneal thickness progression for early keratoconus detection
- Various comparative displays for extensive follow-up
- Pachymetric and topographic maps for individual health care measures
- Comprehensive refractive maps for transparent diagnostics
- Free selectable reference bodies for elevation maps

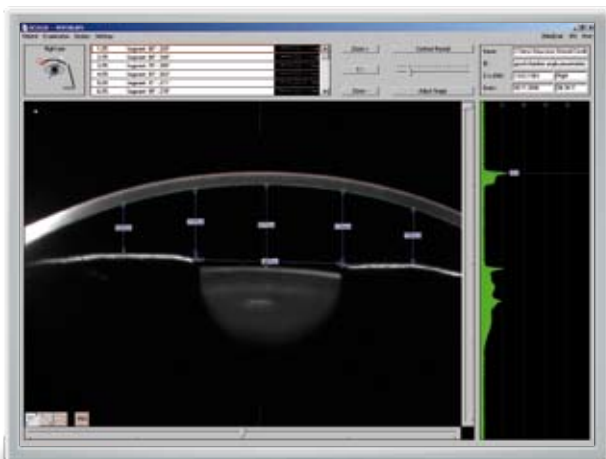
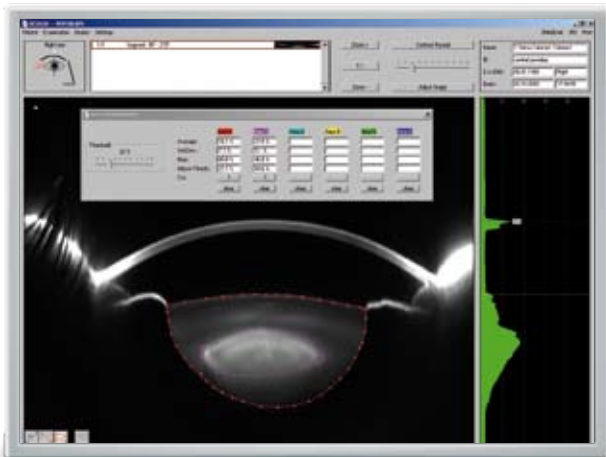
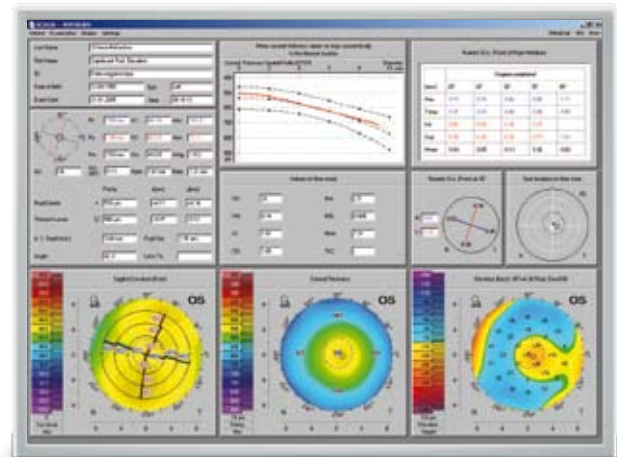

Software Package Cataract:

- ✳ Comprehensive cataract analysis (3D-densitometry) and PNS (Pentacam Nucleus Staging)
 - Cataract can be followed up optimally
 - Position of opacifications are represented (vision- or not vision-relevant)
 - Clear images for the patient (a picture says more than a thousand words)
 - Documentation
- Curvature values of the anterior and posterior corneal surface for improved IOL calculation
- Manual measurements can be taken in Scheimpflug images to determine position of IOLs, pIOLs, iris contours, implants, etc.
- True Net Power Map, determination of true refractive power of the cornea – even and in particular after refractive surgery
 - Selection of toric IOLs
 - Calculation of IOLs
- ✳ Zernike analysis and corneal Wavefront (anterior and posterior corneal surface), e.g. for the selection of aspheric IOLs and determination of higher-order aberrations
- Anterior chamber depths map for glaucoma diagnostics and for pre-surgical planning of phakic IOL implantation
- Overview for cataract surgeon for purposes of pre-surgical planning

Pentacam CLASSIC

The Versatile Model



The Pentacam Classic provides you with a versatile, indispensable diagnostic instrument for surgical preparation. The Classic includes the Basic software and software packages for preliminary refractive examinations and early cataract detection as well as cataract classification. The overall depiction gives you a quick, complete impression of the eye under examination. Informing the patient is facilitated considerably by the graphic representation.

The Pentacam Classic can be upgraded at any time. You will find all optional software modules in the overview on page 17. Moreover, the Pentacam Classic comes with two additional software licences which allow you to transfer examination data to various treatment rooms and evaluate it there.

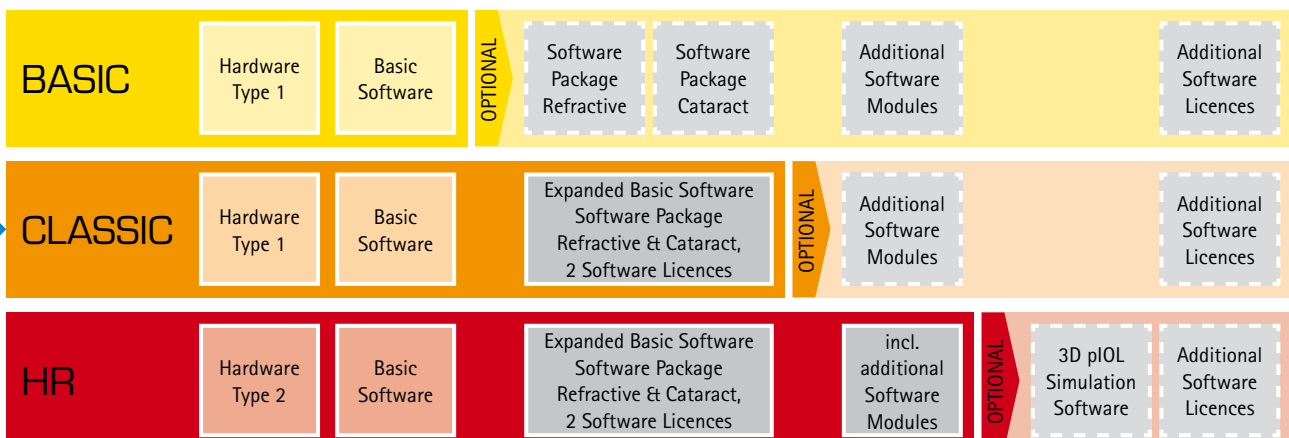

Data Network

A highly efficient practice and more time for your patients

Oculus patient data management software is a standard feature of the Pentacam. Would you like to work with your own practice software? No problem. The Pentacam can be integrated into your electronic medical record (EMR) software system quickly and easily. Furthermore, the Pentacam software is full DICOM compatible. By networking your equipment, you can easily save and synchronise all examination data, optimise work processes in your physician's practice or clinic and thus save time and cut costs.

In order to be able to read and process data gathered by the Pentacam, you require a software licence for this workplace. The Pentacam Basic software is included in every software licence. It can be freely configured to suit your specific needs. The software licence is not dependent on a single instrument, e.g., you can also use it to read data from examinations conducted with other Pentacams. The Pentacam Classic and HR include two software licences as standard features so that nothing impedes your efficient work processes.

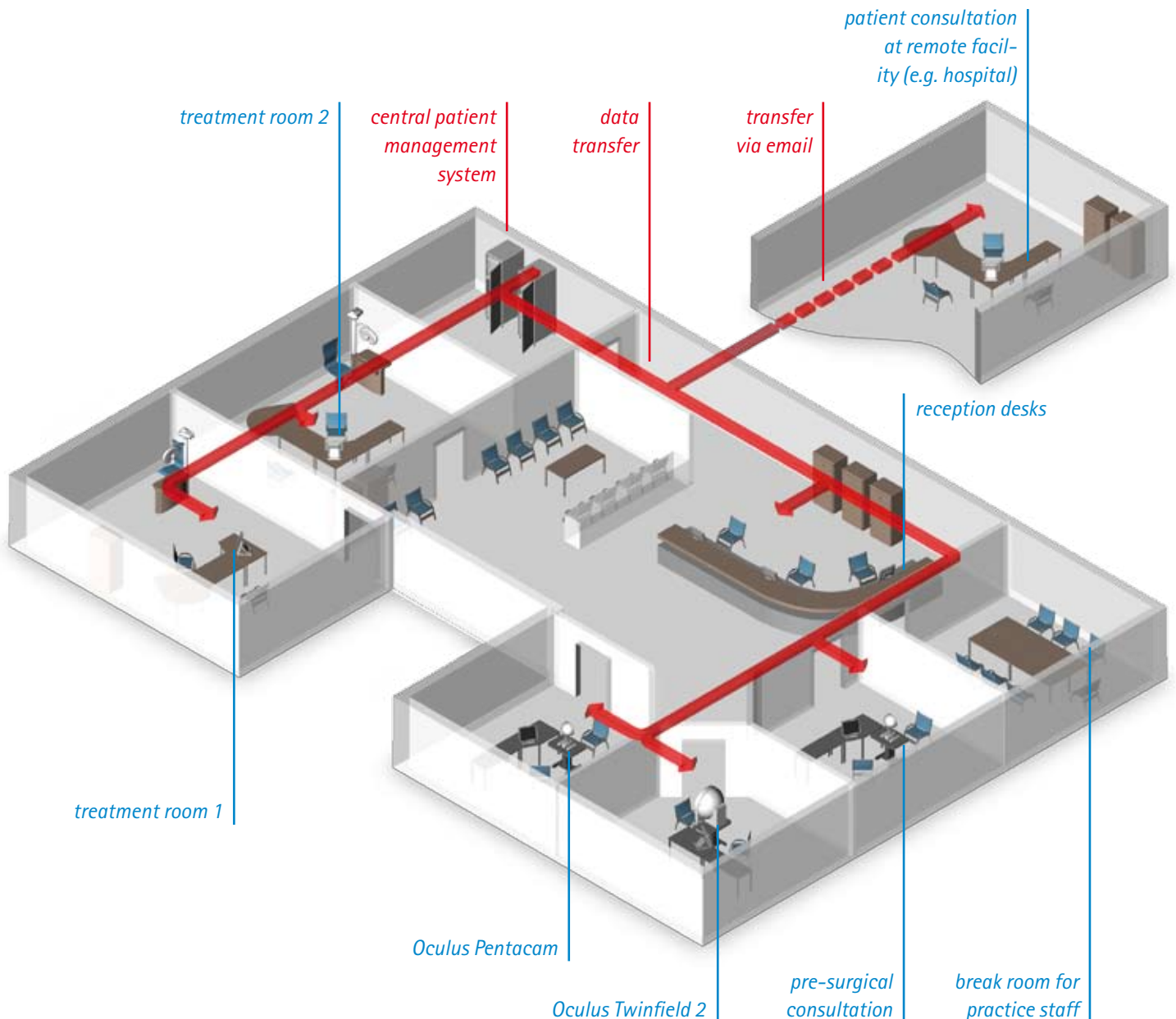

Pentacam HR

The Professional Model



Our high-end model is our high-resolution Pentacam HR. With its brighter and optimized optic it offers you brilliant image quality. Pentacam HR images show you impressive representations of IOLs and phakic IOLs. Corneal irregularities as well as injuries, implantations and refractive interventions are made amazingly visible.

Like the Classic model, the Pentacam HR includes two software licences. The Pentacam HR can be upgraded to include the 3D pIOL simulation software.

This is what makes HR so special:

- Sharp Scheimpflug images for precise representation of implants, corneal rings, opacities for lens and cornea, etc.
- ✦ Precise imaging for determining positions of pIOLs and IOLs in reference to centering and tilting (in particular toric implants on Scheimpflug images)
- Special Scan Mode for optimal representation of IOLs
- ✦ Precise measurements of cornea with 100 Scheimpflug images in 2 seconds
- Possibility to shift fixation to make the fixation process easier for patients with high ametropia
- Can be upgraded to include optional software module for 3D pIOL simulation for determining their position in the anterior chamber including aging prediction

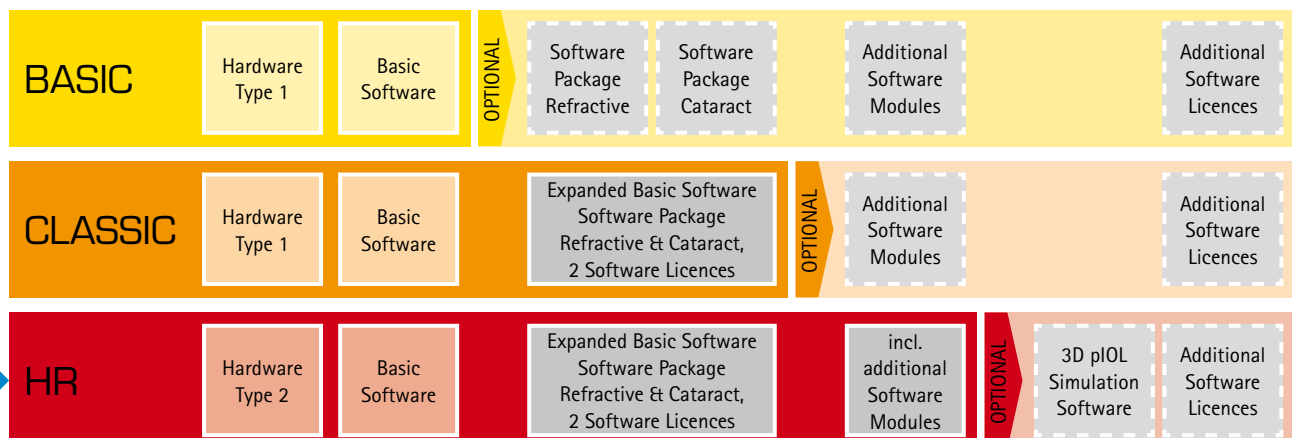

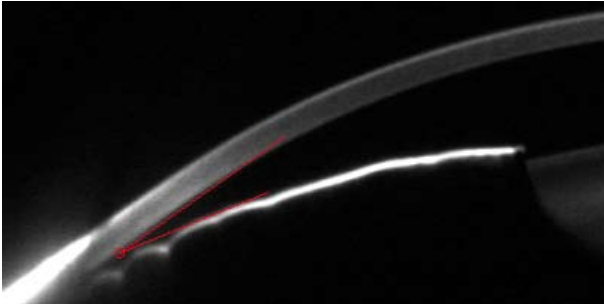

Glaucoma screening

The Pentacam provides a comprehensive and completely automatic analysis of the anterior chamber. Immediately after the eye has been examined, the instrument displays whether the patient has an increased risk for glaucoma. Post-operative evaluation of the anterior chamber shows alterations, e.g. after an iridectomy or other surgical interventions.

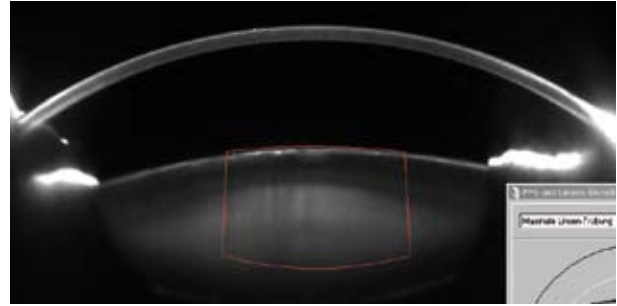

Cataract

The Scheimpflug images produced by the Pentacam supply a clear representation of lens opacity. The 3D cataract analysis combined with the PNS (Pentacam Nucleus Staging) is a unique feature. The centre of the cornea and its anterior and posterior surfaces are measured very precisely for optimal calculation of the refractive corneal power. For your patients this means a perfect calculation of the IOL power – even after refractive surgery.

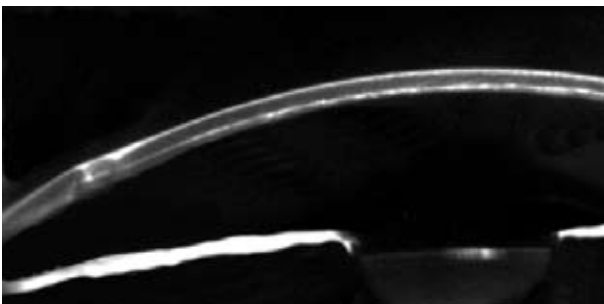

Cornea

The Pentacam stands out by virtue of its high-resolution images and precise measurements for optimal surgical planning. Intelligent analysis programs help to substantiate your decisions further. Surgical success is documented completely from start to finish. Even the smallest irregularities in the healing process are detected early. An examination using Pentacam offers your patients the highest degree of safety.

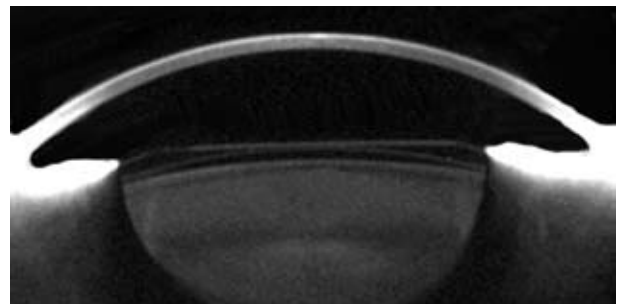

Cataract refractive surgery

On the basis of measurements made by the Pentacam one can determine whether the eye is suitable for surgical intervention or not. The surgery can be explained to the patient on the basis of the obtained results in clear and easy terms.

In addition the Pentacam offers the possibility to simulate in 3D the location of phakic IOLs, including simulation of age-related growth of the crystalline lens. The selection of the aspheric IOL for purposes of reducing spherical aberrations is improved considerably by the unique corneal wavefront. The position of the implanted IOL can be located on the Scheimpflug image and assessed in detail in terms of centering and tilting.

Discover the Possibilities

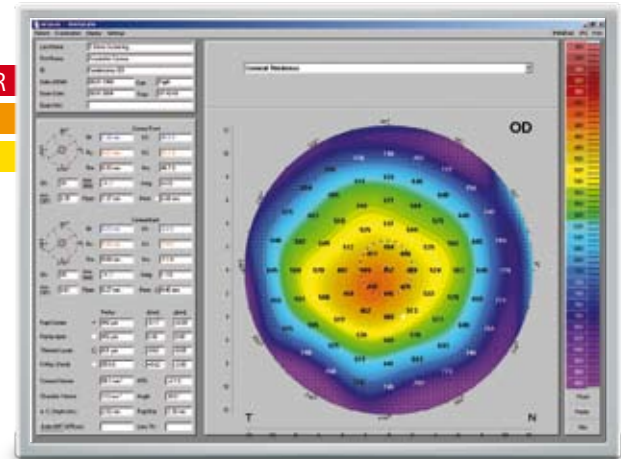
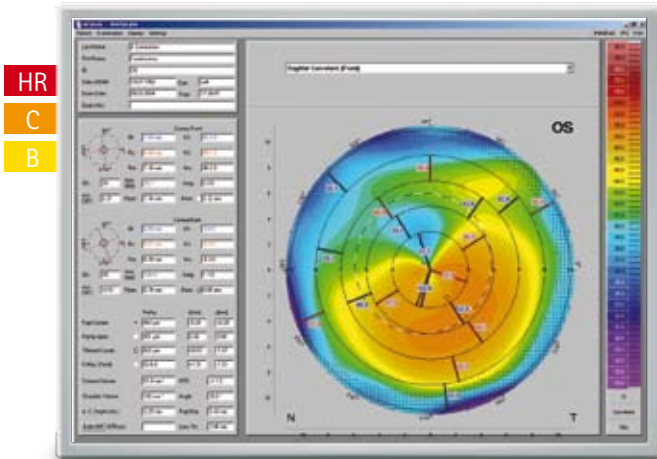

Topography Maps of the Anterior and Posterior Corneal Surface

Applications:

- Keratoconus detection
- Pre-surgical planning of refractive corneal surgery
- Follow-up after corneal surgery
- Calculation of IOL refractive power
- Planning of astigmatism-reducing incisions (LRI)
- Follow-up after refractive surgery (pre-post LASIK, PRK; PKP, LKP, DSEK)

Details:

The rotating measurement principle guarantees high resolution of the measuring points in the central cornea. Topographic analysis of the anterior and posterior corneal surfaces is based on the measured real height data. These provide the basis for

- Sagittal (axial), tangential (local) curvature maps, refractive power maps
- Various elevation maps in relation to freely selectable reference bodies
- True Net Power – calculation of real refractive corneal power taking the posterior surface into account
- Various four-colour maps, pre-set or individually configurable
- Differential and comparative representations of various examinations

Pachymetry Maps

Applications:

- Pre-surgical planning of refractive corneal surgery
- Absolute and relative presentation
- Glaucoma screening
- Relative pachymetry map for early keratoconus detection
- IOP correction taking into account measured corneal thickness based on various correction formulas (for e.g. Ehler, Shah, Dresden etc.)

Details:

An overview representation in colour shows the corneal thickness from limbus to limbus. The measured values can be displayed in a pre-determined grid or represented manually at any point via mouse click.

Automatic representation of:

- corneal thickness in the centre of the pupil
- corneal thickness in the apex
- the thinnest point of the cornea
- corneal volume ✖

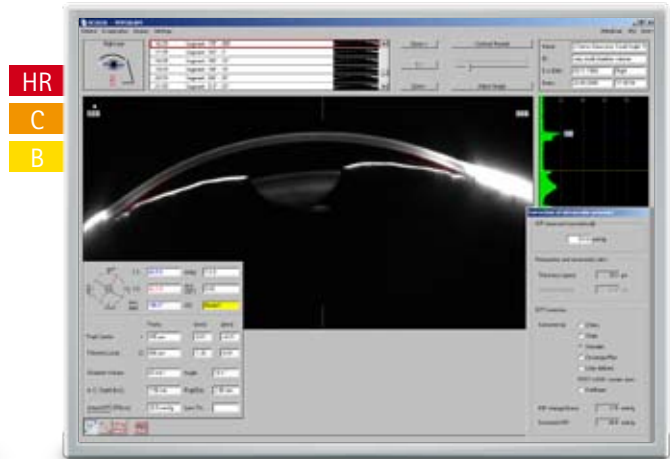

PNS and 3D Cataract Analysis

Applications:

- Objective quantification of lens opacities (densitometry) in 2D and 3D ✖
- Graduation of lens opacities (PNS ✖)
- Visualisation of lens opacities
- Visualisation of posterior capsular opacities (PCO)
- Representation of Bowman's membrane

Details:

Opacities of the natural lens are made visible by blue light illumination. The excellent quality of the Scheimpflug images allows for automatic and objective quantification of lens opacities.

3D Anterior Chamber Analysis

Applications:

- Pre-surgical planning of implantation of phakic IOLs
- Glaucoma screening
- Pre- to post-operative comparison of changes in anterior chamber, e.g. after Iridectomy

Details:

- Manual measuring function in the Scheimpflug images
- Colour anterior chamber depth map
- Tomographic representation, virtual model of anterior segment
- Automatic calculation of
 - Anterior Chamber Angle (ACA) in 360°
 - Anterior Chamber Volume (ACV)
 - Anterior Chamber Depth (ACD), intern or extern

HR / HR	included/optional in the Pentacam HR
C / C	included/optional in the Pentacam Classic
B / B	included/optional in the Pentacam Basic

✖ These functions are unique and are only available with the Oculus Pentacam *

Discover the Possibilities

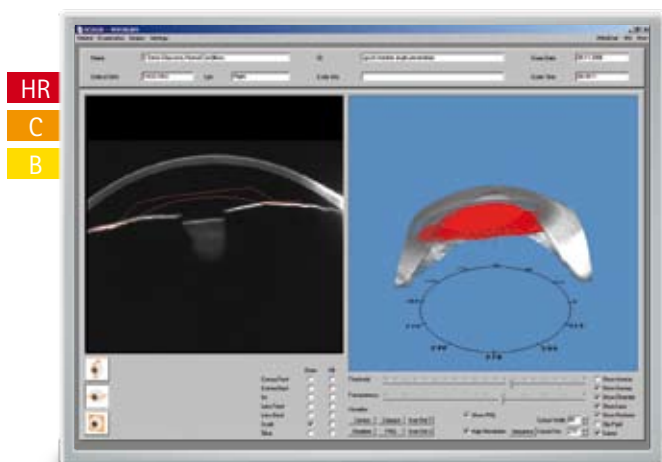

Anterior Segment Tomography

Applications:

- Fast overview of gathered data
- Changes which become visible in the Scheimpflug image are represented amazingly well in a 3D model.

Details:

The rotatable, moveable 3D model of the anterior eye segment proves to be an enormous help in patients education. The patient can see his eye from all sides. Irregularities can be explained easily in this way.

A picture says more than a thousand words.

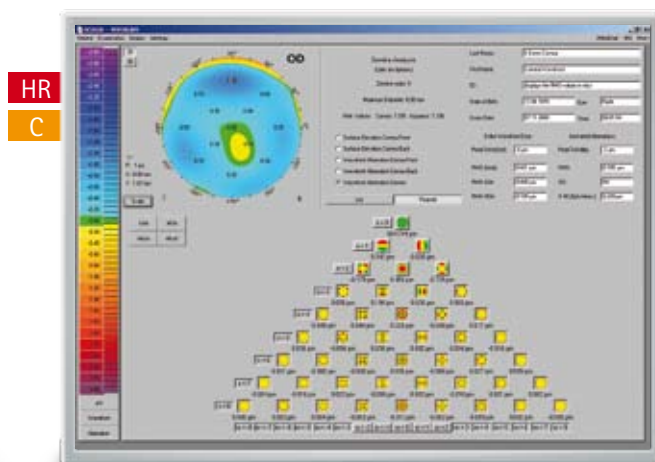

Corneal Wavefront Analysis

Applications:

- Selection of aspheric IOLs for correction of corneal spherical aberrations (Z4.0)
- Fitting of corneal rings in reference to the axis of the coma
- Determination of low and high order aberrations

Details:

The Zernike Analysis of the Pentacam consists of two parts:

- The calculation of the corneal wavefront in its entirety (anterior and posterior corneal surface) is performed via ray tracing – and is thus independent of the shape of the cornea (post LASIK, PRK, LKP, PKP etc).
- The surface based Zernike Analysis is performed using e. g. a theoretical, optimal corneal ellipse (ecc= 0.751). It can be shown for the anterior and posterior surface of the cornea.

Optional Software Modules

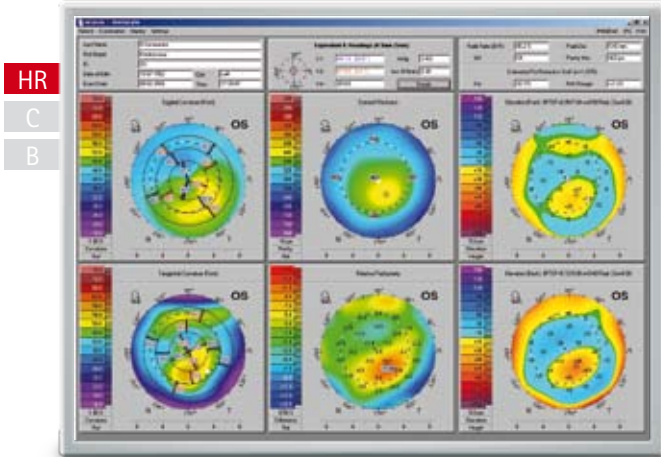

Holladay Report and Holladay EKR Detail Report

Applications:

- Comprehensive clinical comparative representation
- EKRs (Equivalent Keratometer Readings) for optimised IOL-calculation in post-refractive patient eyes ✖

Details:

The Holladay Report was developed in collaboration with Jack T. Holladay, M.D.. It supplies data for calculating the optimal IOL refractive power for patients who have undergone refractive corneal surgeries such as LASIK, PRK and RK. The Holladay Report calculates the real relationship of the posterior corneal surface to the anterior corneal surface. The overall refractive power of the cornea is calculated and described using the EKRs (equivalent keratometer readings) in various zones. They can be used for customary IOL formulas.

HR	/	HR	included/optional in the Pentacam HR
C	/	C	included/optional in the Pentacam Classic
B	/	B	included/optional in the Pentacam Basic

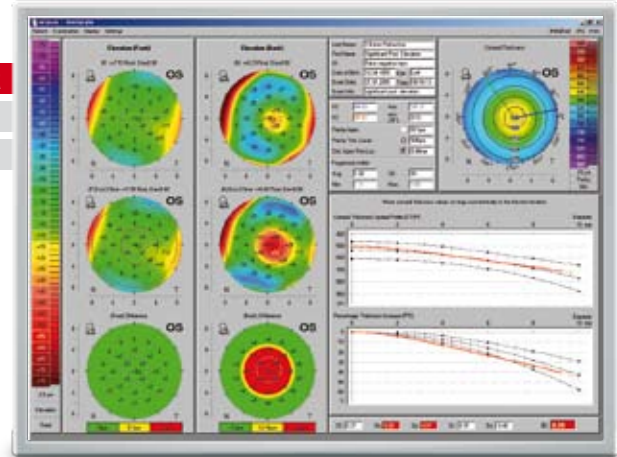

Belin/Ambrosio Enhanced Ectasia Display ✖

Applications:

- Extremely sensitive early keratoconus detection and evaluation
- Reliable detection of a forme fruste keratoconus in very early stages

Details:

The Belin/Ambrosio display is the first screening tool which represents height data of the anterior and posterior corneal surface in combination with an progression analysis of the corneal thickness. It was developed in collaboration with Michael W. Belin, M.D. and Renato Ambrosio Jr., M.D.. In addition to its overall more precise keratoconus detection this screening facilitates early detection in particular. The corneal thickness progression analysis is calculated using concentric rings, starting at the thinnest point and extending to the periphery.

The evaluation of deviations from the standard elevation map and the expanded elevation map is made easier by displaying the results in green, yellow and red.

Several single indices are individually calculated. They are combined into one global index and displayed:

- White stands for: inconspicuous,
- Yellow stands for: suspicious
- Red stands for: possibly a pathological finding.

✖ These functions are unique and are only available with the Oculus Pentacam*

Optional Software Modules

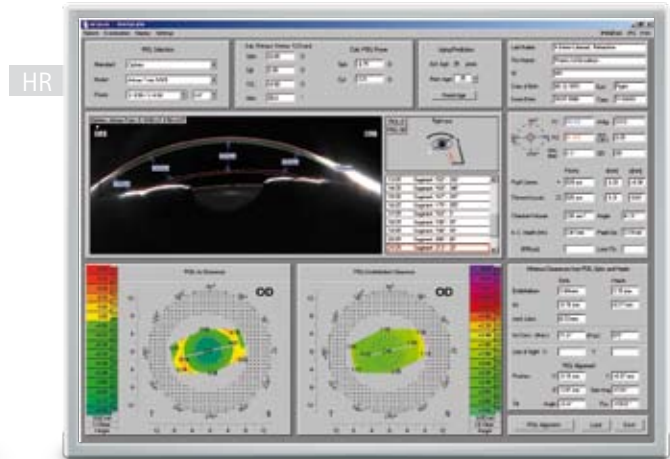
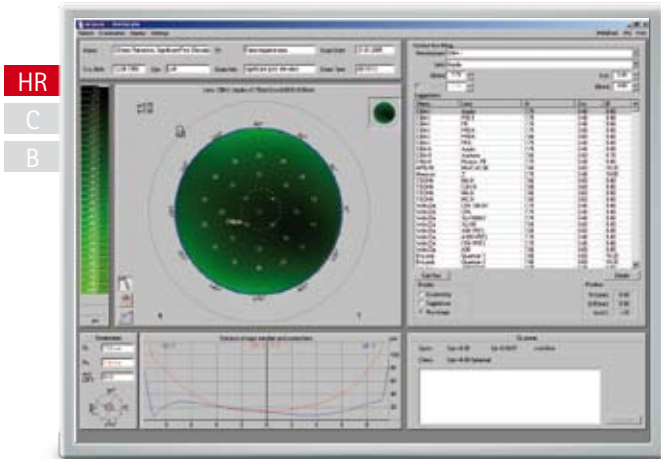

Contact Lens Fitting

Applications:

- Automatic display of all necessary measurement data for fitting contact lenses
- Automatic suggestions for contact lenses
- Realistic fluo image simulation
- Integrated, expandable data bank with over 65,000 lens geometries

Details:

With dynamic fluo image simulation, the fit of the contact lens from the integrated database can be viewed. The simulation makes it possible to adjust inclination and to shift the contact lens while automatically making a new fluo image calculation. The integrated and expandable data bank contains over 65,000 lens geometries. The contact lens geometries can be adjusted individually in cases where fitting is difficult. The user can establish his own rating list for contact lens manufacturers and can expand the database with new or further contact lenses.

3D pIOL Simulation Software ✖

Applications:

- Pre-surgical planning of an iris-supported phakic anterior chamber lens
- Simulation of post-operative position of the phakic anterior chamber lens
- Simulation of age-related lens growth and the position of the anterior chamber lens resulting from this ✖

Details:

The examiner enters the data on the subjective refraction. Depending on the type of lens in question, the software calculates the necessary refractive power of the pIOL. The examiner selects a phakic IOL from the current data bank accordingly. The position of this pIOL in the anterior chamber is calculated in 3D and represented in Scheimpflug images. The minimal distances between the phakic IOL and the crystalline lens as well as between the pIOL and the endothelium are calculated automatically in 3D. This is represented in colour and numerically. This enables the examiner to give the patient visualised information and facilitates patient selection.

✖ These functions are unique and are only available with the Oculus Pentacam*

All Features at a Glance

Features	BASIC	Package Refractive	Package Cataract	CLASSIC	HR	Item Number
Item Number	70700	70811	70812	70830	70900	
Scheimpflug image	●			●	●	
Topography maps of the anterior and posterior corneal surface	●			●	●	
Pachymetry maps, absolute and relative	●			●	●	
Elevation maps of the anterior and posterior corneal surface	●			●	●	
3D Anterior chamber analysis	●			●	●	
Anterior segment tomography	●			●	●	
General overview display	●			●	●	
Keratoconus detection and classification, topometrically	●			●	●	
Four maps, refractive	●			●	●	
Comparative and differential analysis of two examinations	●			●	●	
Freely selectable reference bodies for elevation maps		●		●	●	
Overview display for refractive surgeons		●		●	●	
Corneal thickness progression analysis for early keratoconus detection		●		●	●	
Four maps, freely selectable		●		●	●	
Side-by-side comparison of two examinations		●	●	●	●	
Extended comparative and differential analysis of up to four examinations		●	●	●	●	
Side-by-side comparison of topometric and pachymetric data		●	●	●	●	
Anterior chamber angle in 360°, automatically			●	●	●	
Four maps, anterior chamber			●	●	●	
Four maps, topometric			●	●	●	
Anterior chamber depth map			●	●	●	
True measurements in the Scheimpflug images			●	●	●	
True Net Power			●	●	●	
Corneal wavefront and Zernike analysis of the total cornea			●	●	●	
Optional software modules						
PNS and 3D cataract analysis	○		●	●	●	70727
Contact lens fitting	○			○	●	70726
Belin/Ambrosio Enhanced Ectasia	○			○	●	70728
Holladay Report and Holladay EKR Detail Report	○			○	●	70729
3D pIOL simulation software including aging prediction					○	70928
Additional software licences included	0	0	0	2	2	70909

● included ○ optional

* All statements made in this brochure are correct to the best of Oculus' knowledge as of the printing date.

Technical Data

All Pentacam Models

Feature	Pentacam® Basic/Classic	Pentacam® HR
Camera	digital CCD camera	digital CCD camera
Light source	blue LEDs (475 nm UV-free)	blue LEDs (475 nm UV-free)
Processor	DSP with 400 mil. operations/s	DSP with 400 mil. operations/s
Speed	50 images in 2 seconds ¹⁾	100 images in 2 seconds ²⁾
Dimensions (HxWxD)	535x280x360 mm	535x280x360 mm
Weight	9 kg	9 kg
PC minimum requirements	Pentium IV, 1.5 GHz, Windows XP, 1 GB RAM, VGA graphic card 1024 x 768 true colour, SB interface	Pentium IV, 1.5 GHz, Windows XP, 1 GB RAM, VGA graphic card 1024 x 768 true colour, SB interface

Measurement Range	Pentacam® Basic/Classic	Pentacam® HR
Curvature	3 – 38 mm 9 – 99 D	3 – 38 mm 9 – 99 D
Precision	± 0,2 D	± 0,1 D
Reproducibility	± 0,2 D	± 0,1 D
Operating distance	80 mm	80 mm

¹⁾ Scheimpflug image of the entire anterior segment

²⁾ Cornea fine scan

CE in accordance with Medical Products Directive 93/42/EEC

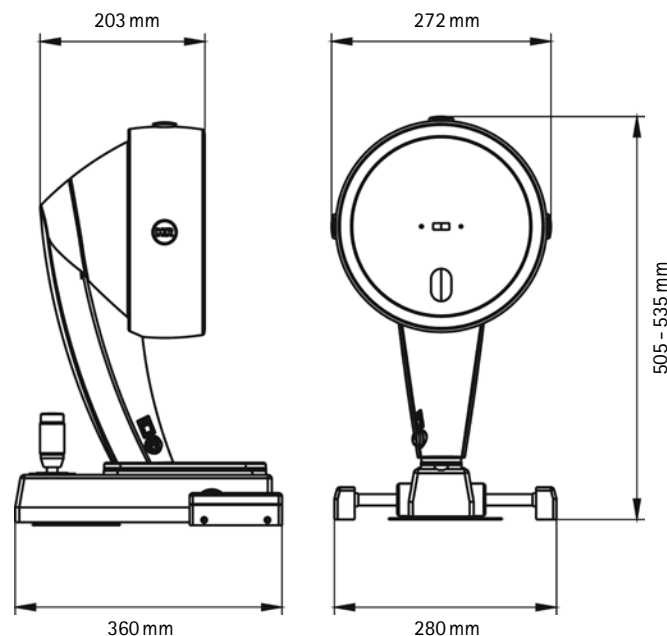

WWW.OCULUS.DE



Oculus is certified by TÜV according to
DIN EN ISO 13485:2003/DIN EN ISO 9001:2000

OCULUS Optikgeräte GmbH

Postfach • 35549 Wetzlar • GERMANY
Tel. +49-641-2005-0 • Fax +49-641-2005-295
E-Mail: export@oculus.de • www.oculus.de

OCULUS Inc., USA

#112 • 2125 196th Street SW • Lynnwood • WA 98036
Toll free 1-888-284-8004 • Fax +1-425-670-0742
E-Mail: sales@oculususa.com • www.oculususa.com