



OCULUS EASYFIELD



OCULUS EASYFIELD

The right choice for all your needs

The Oculus Easyfield is an exciting compact perimeter to do static perimetry up to 30°. It has been designed for the combined use as a visual field screener and perimeter, offering features usually available only in large units.

The integrated bowl with a 11.81" (30cm) radius and distance corrected lens is adapted to the Goldmann standard and fulfills the ISO-norm 12866 for perimeters.

The Easyfield has a fixed point grid with 135 test locations including 30-2.

It delivers standard field indices and on the computer software even the Brusini staging of Glaucoma.

With these main features, it is especially suitable for all Glaucoma testing and follow up, as well as most other visual field examination purposes.

3 Different test methods

- Fast threshold
- Normal threshold (4/2)
- Suprathreshold

The right choice for all your needs

- small
- compact
- light-weight
- intelligent
- based on classical perimeter principles – a second perimeter is not required to verify results
- advanced statistics and analysis software available

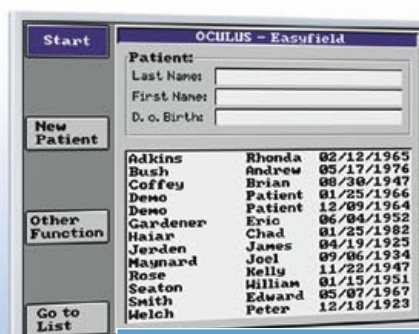

patients database

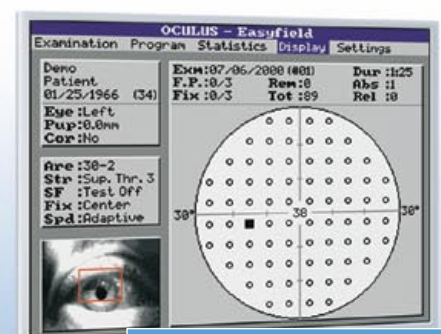

screening result

Main features

- **EASY TO USE** with color LCD-display
- **EASY TO START** (switch on for instantaneous start – no program booting)
- **EASY FIXATION MONITORING** with built-in CCD-camera and direct patient observation
- **EASY TO STORE** up to 40,000 examinations in control unit
- **EASY TO WORK** with statistical functions (greyscale, cumulated loss curve, indices calculation)
- **EASY TO TRANSFER** patient's data to a separate PC for backup
- **EASY TO ADAPT** to the patient by fine vertical adjustments of the moving cone
- **EASY TO SERVICE** – no bulb to change – no moving parts to adjust
- **EASY TO PRINT** the results with a built-in printer



→ Easyfield LC with optional accessories

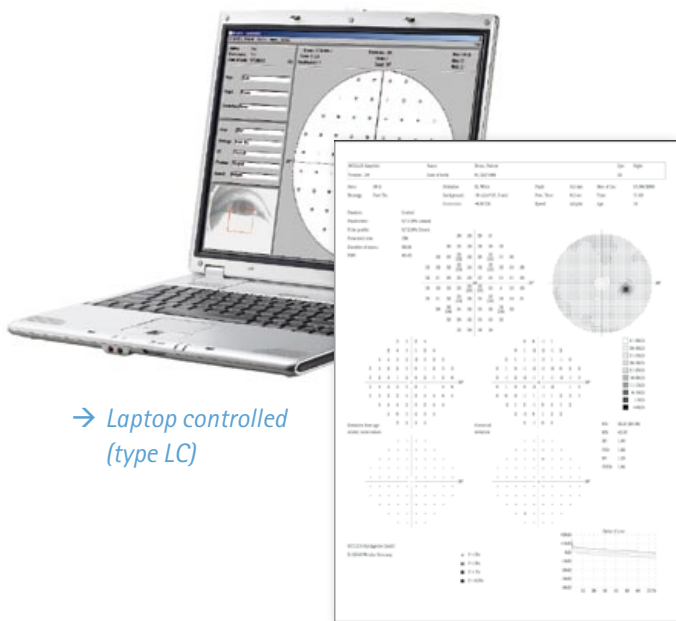

→ Laptop controlled (type LC)

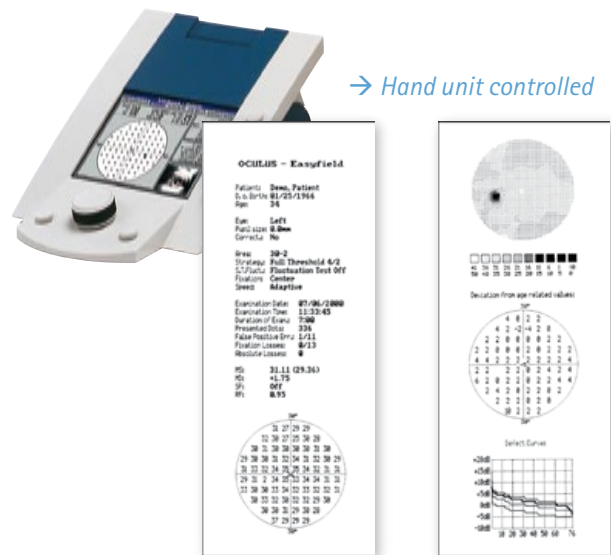

→ Hand unit controlled

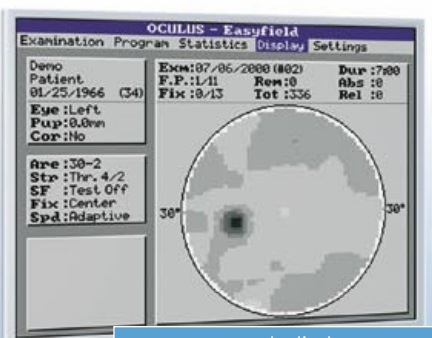

greyscale display

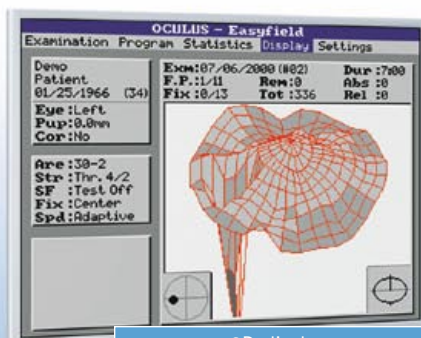

3D-display

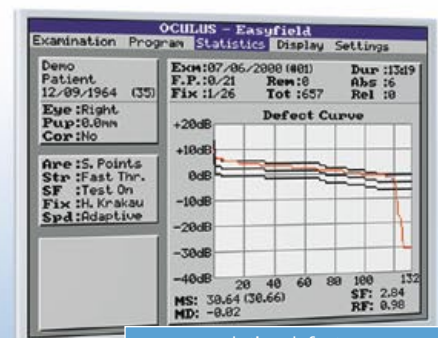

cumulative defect curve

Technical Data – Oculus Easyfield

Perimeter bowl radius	r=11.81" (30 cm)
Test point parameters	Corresponding to the Goldmann Standard
Stimulus size	III
Stimulus luminance range	0 – 3180 cd/m ² (10000 apostilbs)
Stimulus luminance increments	0.1 log steps
Speed of examination	Adaptive, fast, normal, slow
Test point color	White
Eccentricity	30°
Background brightness	10 cd/m ² (32 apostilbs)
Fixation control	CCD camera, central threshold, Heijl-Krakau
Patient positioning	Headrest adjustable, moving cone
Weight	10 lb (4.6 kg)
Accessories	Approx. 2.8 lb (1.3 kg)
Electrical operating voltage	All normal voltages from 100–240V
Interface	RS232/V24, SubD
Monitor	Color LCD-display
Storage	40,000 patient treatments in control unit and data transfer to PC for backup possible
Software	Installed on hand control unit (not with type LC). Also included for backup, control and print on Windows™-PC
PC minimum requirements	CPU: Pentium1 or higher OS: WIN98 or higher Free space on hard disk: 10MB + 2 KB/examination
Static perimetry	
Strategy	Classical (4/2) threshold Fast threshold, adapted to surroundings Age- or suprathreshold oriented screening (2 or 3-zone, quantify defects)
Test point grid	30–2, 24–2, 10–2, Sectors, Single test points



CE According to Medical Device Directive 93/42/EEC

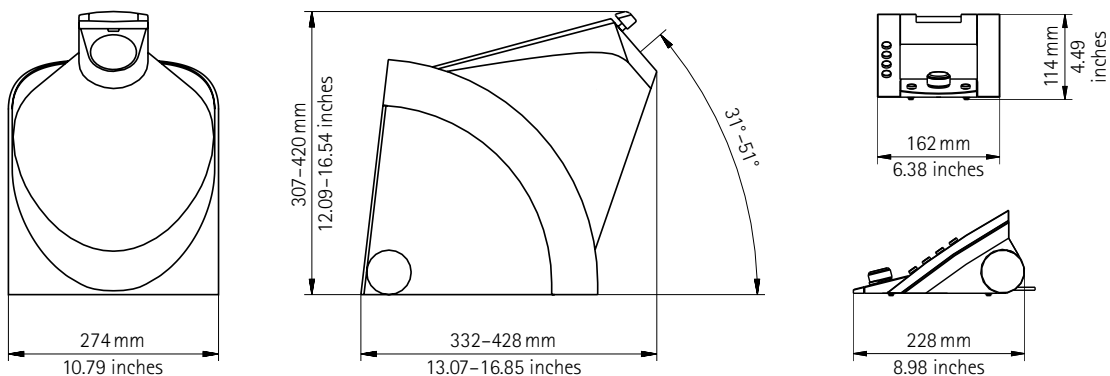

WWW.OCULUS.DE

OCULUS Optikgeräte GmbH
Postfach • 35549 Wetzlar • GERMANY
Tel. ++49-641-2005-0 • Fax ++49-641-2005-295
E-Mail: export@oculus.de • www.oculus.de

OCULUS Inc.
#112 • 2125 196th Street SW • Lynnwood • WA 98036
Toll free 1-888-284-8004 • Fax ++1-425-670-0742
E-Mail: sales@oculususa.com • www.oculususa.com



Oculus is certified by TÜV according to
DIN EN ISO 13485:2003/DIN EN ISO 9001:2000

